



الموارد المتجددة للإستشارات الهندسية
Renewable Resources for Engineering Consultancy

*Sun Can Light`
Our Future*

About Renewable Resources Consultancy

Renewable Resources for Engineering Consultancy (RRC) Is a part of group (contracting, trading & consultancy), RRC established on 2017 as a specialist consultancy office in Renewable Energy & Energy Auditing Renewable Resources for Engineering Consultancy has been established to provide the Saudi market with the appropriate expertise in the field of solar energy. RRC supports relevant bodies with the necessary studies and specialized designs, supervising the installation of renewable energy systems and carrying out the necessary tests before connecting the system to the grid.

RRC engineers have obtained the certification of solar energy designers accredited by Saudi Electricity Company (SEC) , as the first engineers in Saudi Arabia they receive this accreditation.



RRC supports a number of activities such as the training of engineers interested in this field through the holding of specialized courses for engineers and training of technicians on the installation and testing using the latest equipment, tools and technologies in the world in cooperation with the Global Institute of Electrical Engineering GIEE in the United States of America and provide of specialized workshops to educate the community the importance of using and adoption of renewable energy and how to rationalize energy consumption in all aspects of daily life.

RRC provides solutions to our customers in all areas of solar energy, based on accurate scientific and practical analysis by specialized engineers in accordance with global standards. The company has now developed the potential for the construction and operation of megawatt power projects.

At RRC we believe in our responsibility towards the Kingdom and the community and maintain the highest standard of living in a way that does not contradict our responsibility and awareness towards the world we live in by reducing pollution levels and reducing emissions that coming from power generation.

WHY RRC ?

RRC has a team of highly experienced engineers in Saudi Arabia to provide the best energy solutions with the support of stakeholders from many key sectors, EPC Companies and solar power plant developers.

We provide the most effective solutions and studies that help our clients evaluate the proper size of the solar system. In addition we provide the necessary designs and related studies through a comprehensive survey of the site and accurate knowledge of the customer's energy needs.



RRC scope of work

1- Site Survey

Our team do a Site survey and collect information about local conditions and issues before any proposal is made. The information collected is then combined with the load patterns and the customer preferences to make a final proposal.

There are lot of aspects in doing a site survey for a installer. The amount of details a site surveyor collects depends on the scope of project. A detailed analysis might be required if it involves industrial and commercial entities involving lot of equipment and appliances.

In particular, We need to the following in a site assessment:

- A suitable location for Solar Panels.
- Shading Calculation
- Determine Mounting Structure type & location
- Solar Equipment Location
- How is the PV system going to be connected to the existing electrical systems.

2- Solar Systems Design Implementation

RRC specializes in the design of solar systems using modern tools and software .to ensure the highest efficiency and lowest cost.

RRC perform the following designs:

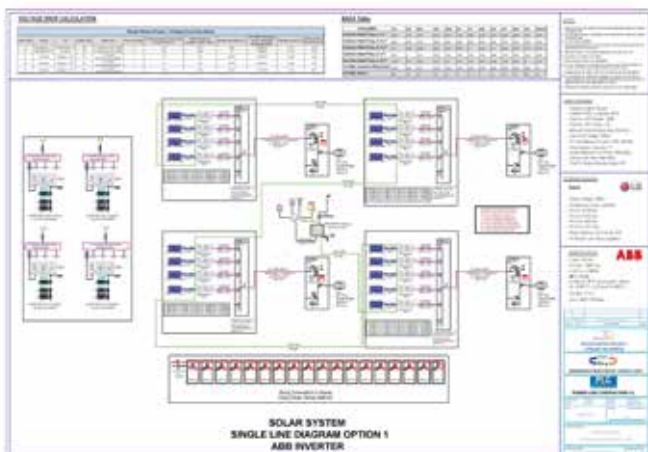

1- On Grid Solar systems Design.

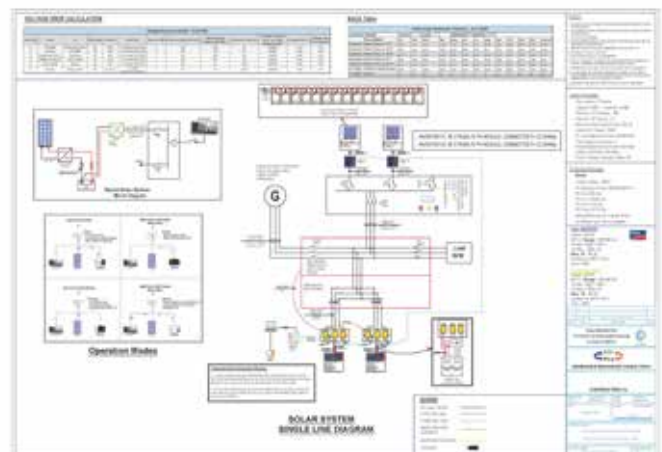

2- Hybrid Solar System Design.

RRC scope of work

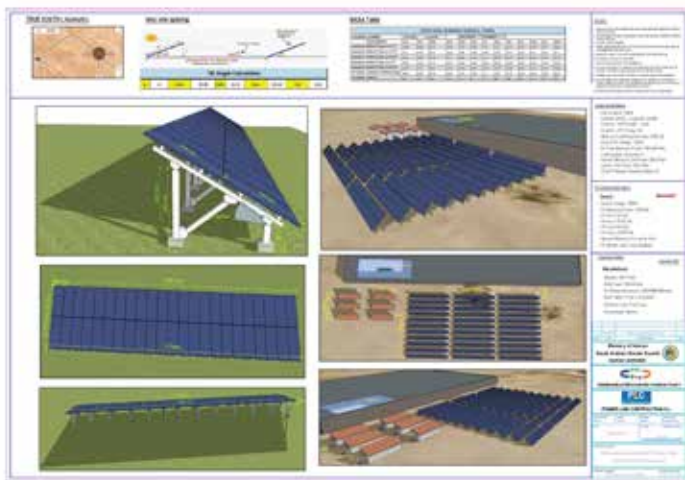

3- Off grid Solar Systems.

Solar pump system

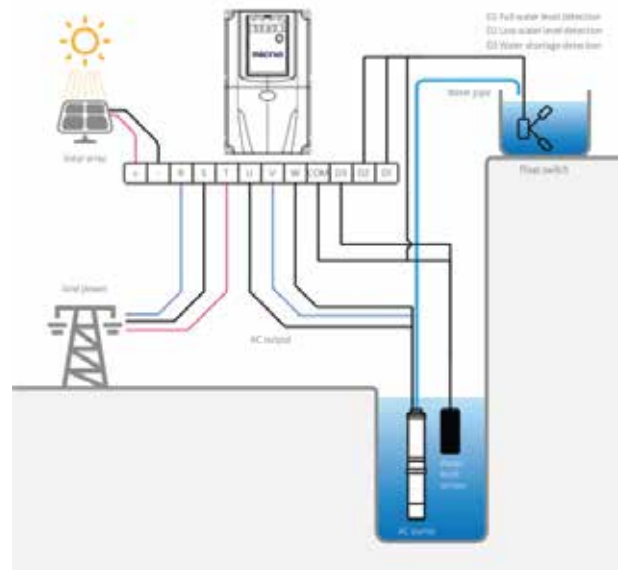

4- Water pumping Solar systems Design.

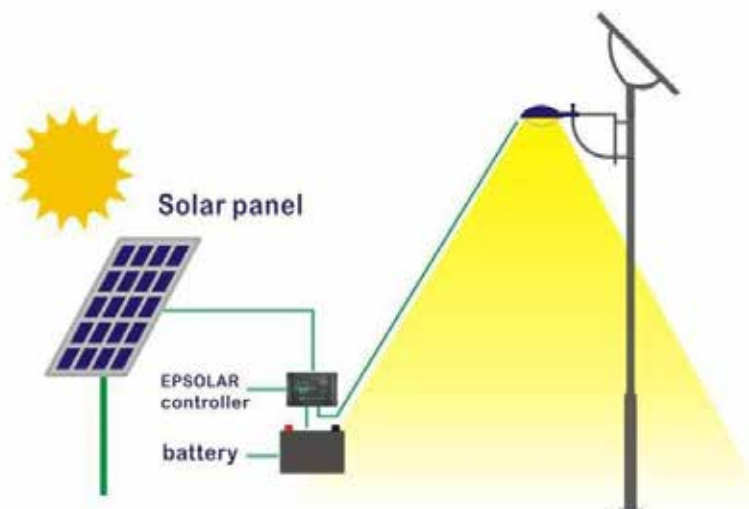

5- Street lighting design.

RRC scope of work

3- Feasibility study

RRC is conducting a feasibility study for solar energy systems, including:

- Cost Study & System Payback period.
- The total value of the financial amount provided after calculating the cost of maintenance.
- Total value of energy saved over the lifetime of the system.



- Derive electricity usage profiles based on historical measured or billing data
- Conduct on-site investigation into suitable areas to install ground-mounted or rooftop or tracker PV systems
- Assess the available solar resource for specific locations based on satellite-derived, time-series data
- Conduct detailed PV electricity production models for accurate long term predictions
- Provide detailed financial analysis and finance models for PV installations

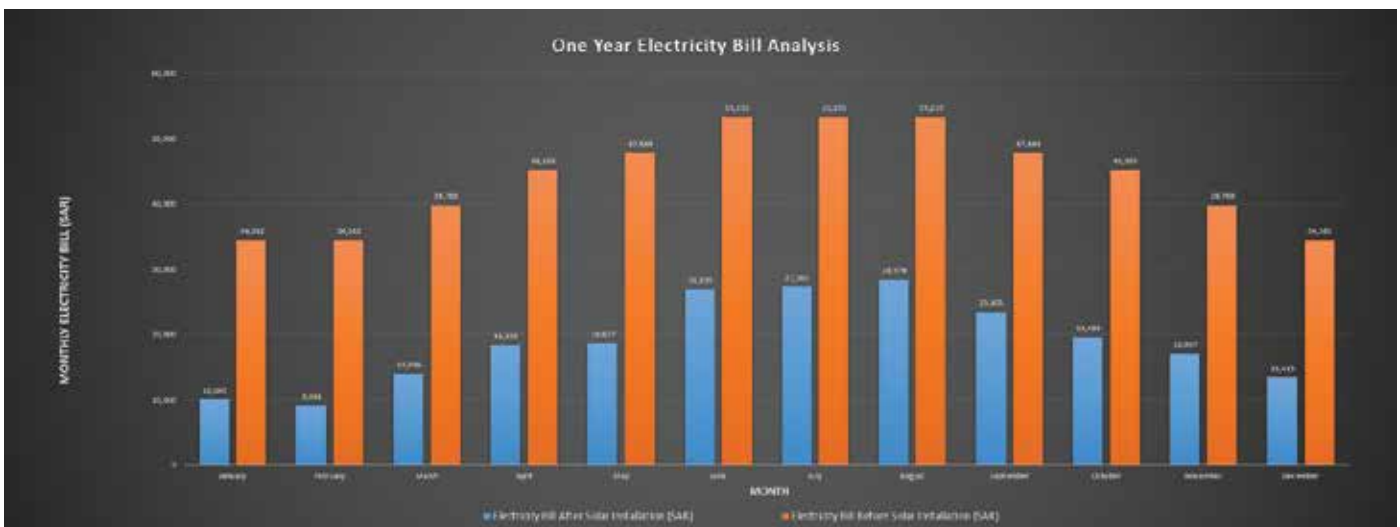

RRC scope of work

4- Supervision of solar Systems Installation

- Review designs if available.
- Verification of the correct arrival of the equipment & Ensure the safety of the materials used and conforms to the specifications.
- Supervision of all key elements of the installation process and commissioning of the site according to the state of the art.
- Supervision of structure assembly and inter wiring of the solar array
- Testing and commissioning of the solar electric power system
- Demonstration of equipment operation and maintenance requirements to customers representatives.



RRC scope of work

5. Conduct the necessary tests.

RRC performs inspections during and after the completion of the installation work to ensure the integrity of the system and its readiness to work and connect the system to the grid.

RRC uses the latest Technologies, including:

- Advanced measuring instruments for voltages and currents.
- Thermal cameras to check the safety of solar panels of workmanship defects.
- Seaward Solar Installation Test Kit.
- Seaward Solar Power Clamp.
- Curves for current and voltages.



RRC scope of work

6- Maintenance manual.

RRC provides the customer with a detailed maintenance manual based on the nature of the system implemented by the client in addition to a detailed statement of the parts that are preferred to exist as an alternative for maintenance purposes, which improves the operation of the system and contributes to maintaining its sustainability.



7- . Energy Audit:

An energy audit is the first step to assess how much energy your building consumes and to evaluate what measures you can take to make your building more energy efficient. An assessment will show you problems that may, when corrected, save you significant amounts of money over time.

Steps of energy audit process :

- Data collection
- Field work
- Analysis of energy consumption and performance of energy accounting:
- Analysis and development of energy saving measures
- Energy audit report



RRC scope of work

8- TENDER PROCESS ASSISTANCE

- Develop detailed technical specifications for PV turnkey projects
- Guide the client through the tender process
- Participate in and advise tender evaluation committee
- Secure the lowest risk and best priced solution from trusted equipment suppliers and installers.

9- Provide Technical Document:

RRC provide a complete set of technical document such as: MS, ITP...,etc.

10- Market Research:

RRC gathers and provides market information for investors and developers and we do Market Statistic support Study.

11- Contract Consultation.

Lease contract, PPA, BOT, BOO...,etc.

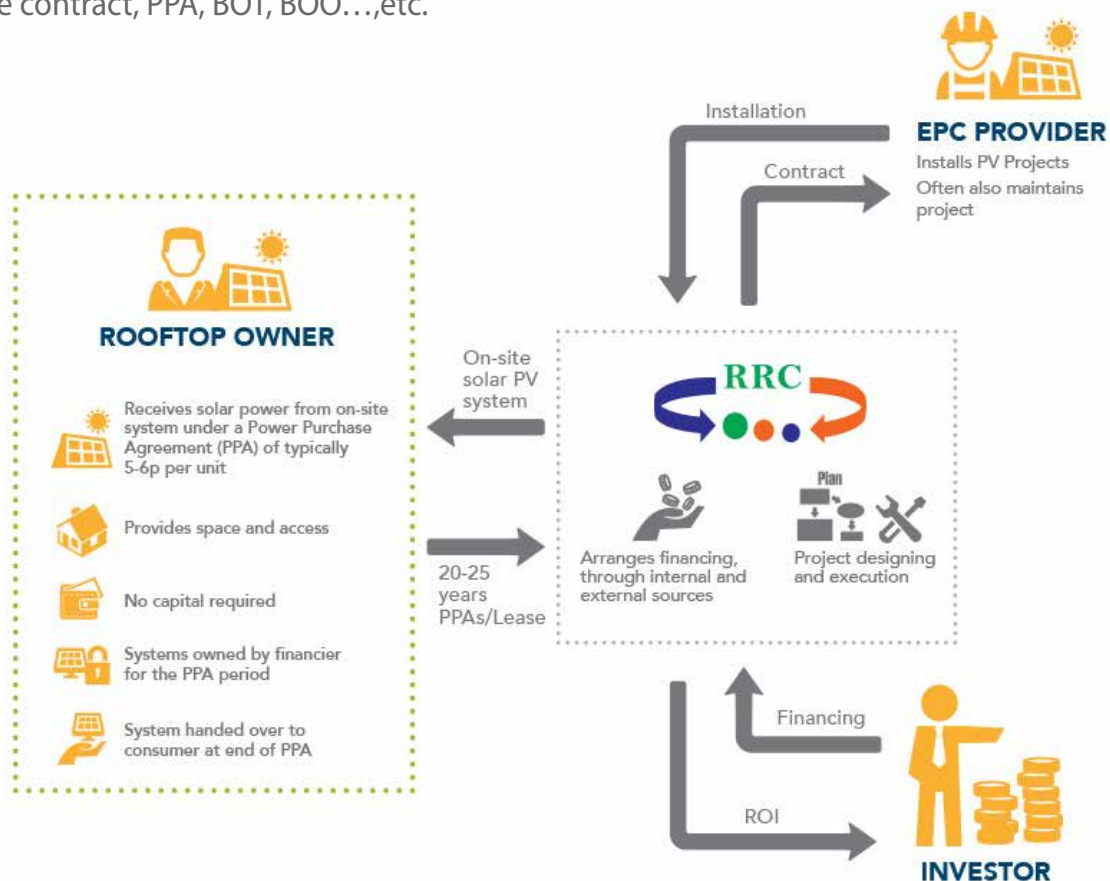

Organization Chart

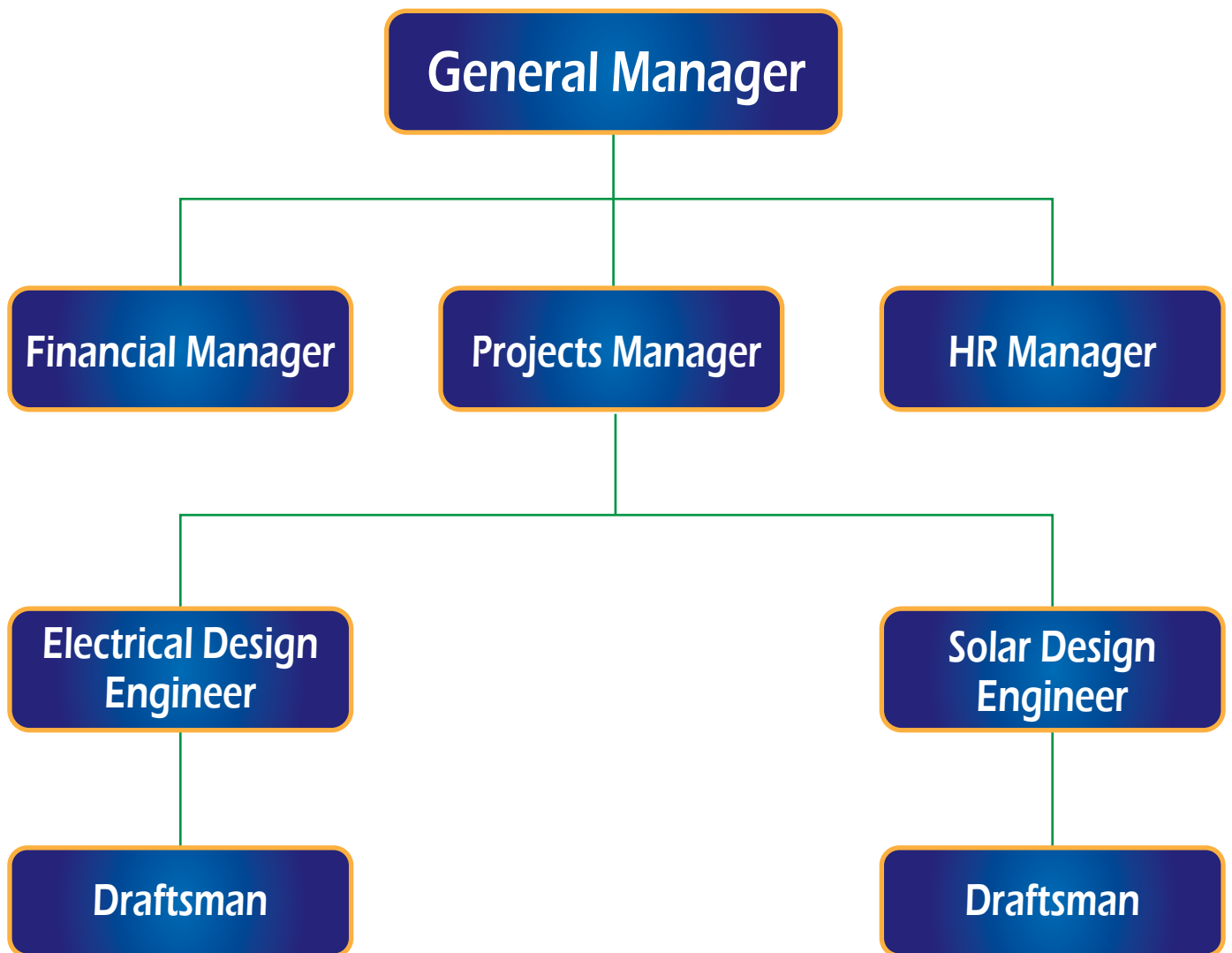

Process Flow Chart

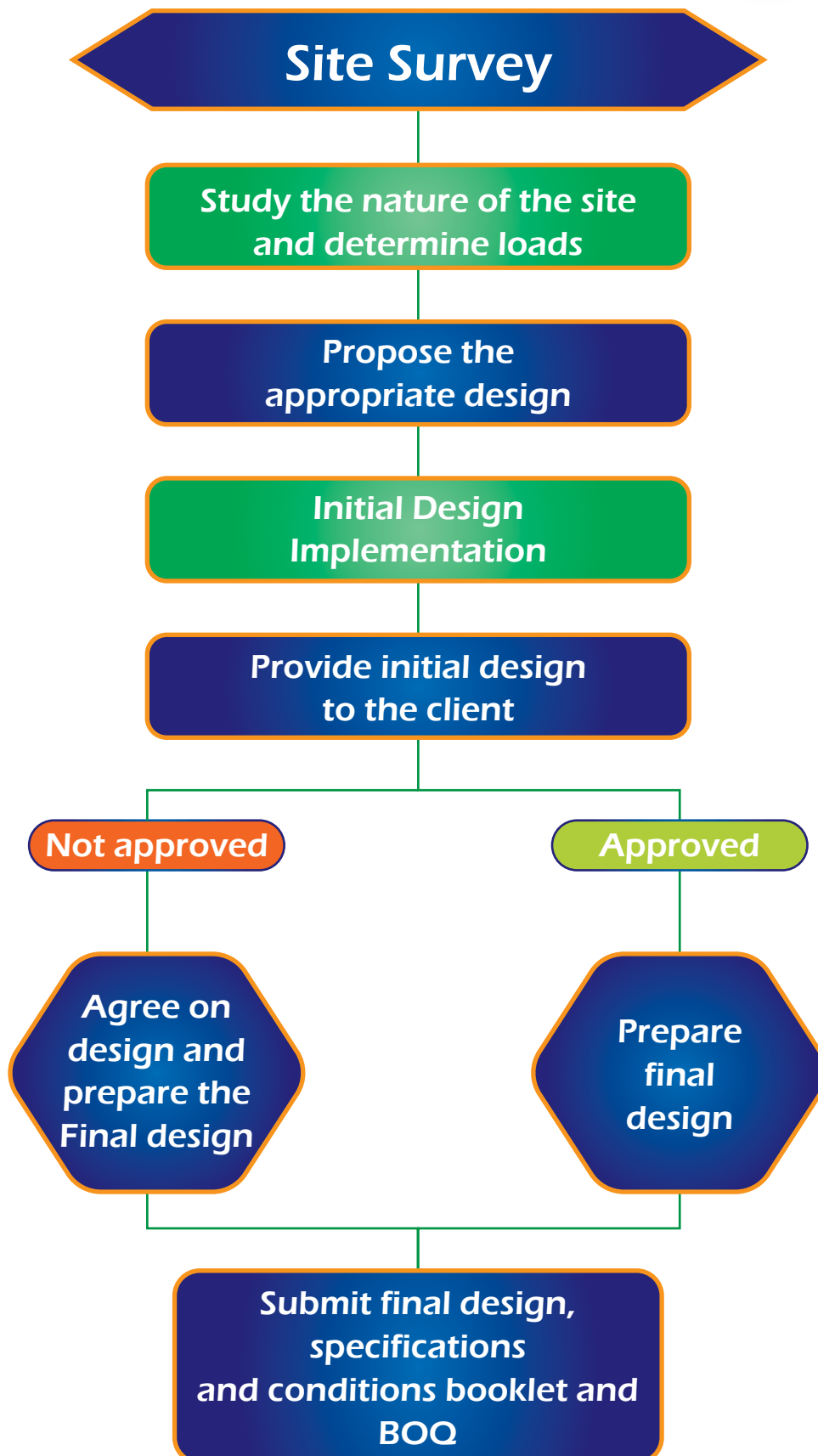

List of Projects

NUM	PROJECT NAME	Capacity (KW)	System Type	Structure Type
1	World Assembly of Muslim Youth	50	On Grid	Concrete Rooftop
2	Saudi Cable Factory	5000	On Grid	Steel Rooftop
3	Shibh Al Jazeera HQ	50	On Grid	Concrete Rooftop
4	Al Othaim Markets	531	On Grid	Steel Rooftop
5	Shibh Al Jazeera-Private Villa	33	On Grid	Concrete Rooftop
6	Wedding hall - Jeddah	100	On Grid	Concrete Rooftop
7	Thamer International School	200	On Grid	Concrete Rooftop
8	Saudi Mining Company (Ma'aden)	4000	On Grid	Concrete Rooftop
9	Ministry of Industry and Mineral Resources	250	Hybrid	Concrete Rooftop
10	Metro Project - West Depot	1000	On Grid	Ground Mounting
11	Al Qassim Farm	200	On Grid	Ground Mounting
12	KANOO - Baker Hughes	2000	On Grid	Ground Mounting
13	Shahin Metal Industries	1000	On Grid	Steel Rooftop
14	Wamest - KFMC	2000	Hybrid	Concrete Rooftop
15	SSCL Private Villa	132	On Grid	Concrete Rooftop
16	InterContinental Riyadh	83	On Grid	Concrete Rooftop
17	Saad Aldeen Sweets	1000	On Grid	Steel Rooftop
18	Abdul Latif Jameel Properties	1500	On Grid	Concrete Rooftop
19	Tarbiya Schools	150	On Grid	Concrete Rooftop
20	Electric-house	150	On Grid	Concrete Rooftop
21	Ministry of Energy	394	On Grid	Concrete Rooftop
22	National Guards	150	On Grid	Ground Mounting
23	Ministry of Transportation	152	On Grid	Ground Mounting
24	Saudia Dairy and Foodstuff Company (SADAFCO)	1460	On Grid	Ground Mounting
25	K.A.CARE Weather Station	6	Hybrid	Ground Mounting
26	Saveto Group (Saudi Vetonit Company Limited)	1000	On Grid	Steel Rooftop
27	Future Earth	2000	On Grid	Steel Rooftop
28	Al Jawhara Developments	2000	On Grid	Concrete Rooftop

Tools & Software





الإدارة الهندسية

Info@rrc-sa.com

المملكة العربية السعودية - طريق الملك عبد الله - ص.ب ٣١٦٤ الرياض ١٢٤٧١ - هاتف: +٩٦٦ ١١ ٢٧٥٣٢٢٤ - فاكس: +٩٦٦ ١١ ٢٦٩٢٧١ - غ.ت: ٤٢٥٦٤٠
Kingdom of Soudi Arabia - King Abdullah Road - P.O.Box 3164 Riyadh 12471 - Tel: +966 11 2753224 - Fax: +966 11 269271 - Chamber of Commerce 425640

www.rrc-sa.com